

DATA SHEET

SCI EL READER WF2

Ref. SCIBT69B



- 👁️ Powerful “ Active RFID gateway” for your WIFI network
- 👁️ Compact and robust aluminium housing dedicated for the industrial applications
- 👁️ Multiples IP protocols supported for the network management with your WIFI network

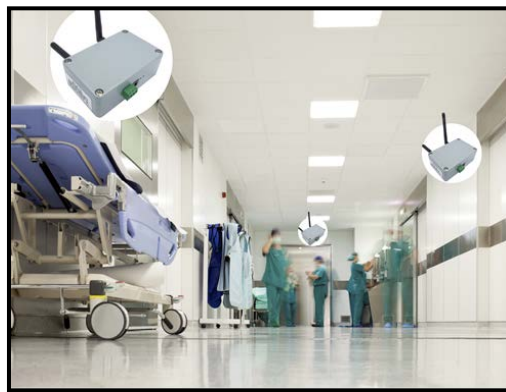

TABLE OF CONTENTS

1	MAIN SPECIFICATIONS	3
2	PACKING INFORMATION	4
3	PHYSICAL INFORMATION	5
3.1	ANTENNAS CONNECTORS	5
3.2	3 PINS TERMINAL BLOCK WIRING	5
3.3	POWER SUPPLY	6
3.4	LED INDICATORS	6
3.5	RESET BUTTON	7
3.6	DIN RAIL MOUNTING	7
4	READER'S OPERATING MODE	8
4.1	PHYSICAL SETUP	8
4.2	SOFTWARE SETUP	9
4.2.1	SETUP THE LANTRONIX WIFI MODULE	9
4.2.2	SETUP AND TEST THE READER WITH ETER	13
4.3	CONFIGURATION COMMAND LIST	14
5	MECHANICAL SPECIFICATIONS	ERREUR ! SIGNET NON DEFINI.
6	REFERENCES AND VERSIONS	16
7	STANDARDS	16
8	DOCUMENT VERSION	16

1 MAIN SPECIFICATIONS

Technical Specifications	
Supply voltage	9-48 VDC
Average supply current	@9V 60mA @12V 50mA @24V 30mA @48V 20mA
Frequency	433,92 MHz (868MHz version : SCIEL READER WF2H)
Reception range	Customizable with a software command
Working temperature	-20°C to +60°C
Supported IP protocols	TCP/IP, UDP/IP, ARP, Telnet, ICMP, SNMP, DHCP, BOOTP, TFTP, AutoIP, HTTP
Settings	Device Installer software (IP network settings) & ETER configuration software (Active RFID settings) running under Windows XP, W7, W8
RFID Antenna connector	SMA-F
Supply connector	DC supply jack: 2.1 mm Pluggable terminal block, with a 3.81 mm step
LEDs	Power (yellow), frame receipt (blinking yellow) Wifi network presence (blue)
Housing	Aluminum with anti-oxidation paint – 98 x 64 x 36 mm
Tightness	IP52
Standards	EN 301 489 – 3 : 2002 V1.4.1 ; EN 300 220 – 2007 : V2.1.2 ; CE ; RoHS certified
Output interface	Interface WLAN WIFI - IEEE 802.11 b/g/n (2.4 GHz only) Open Collector output (0.1A, 30V)
Wifi antenna connector	SMA-F-RP
Accessories	Black articulated WIFI antenna integrated SMA-M BNC antenna converter included Mini straight RFID 433MHz antenna included Male Power Supply removable connector included DIN RAIL mounting clip – DIN CLIP01 (not included)

2 PACKING INFORMATION

The packaging of the **SCIEL READER WIF12**, reference SCIBT69B, contains:

- 🔍 **The SCIEL READER WIF12 itself, packed in a ESD plastic bag**
- 🔍 **Its articulated wifi antenna**
- 🔍 **A 433MHz RFID mini antenna**
- 🔍 **A SMA-male to BNC-female adapter**

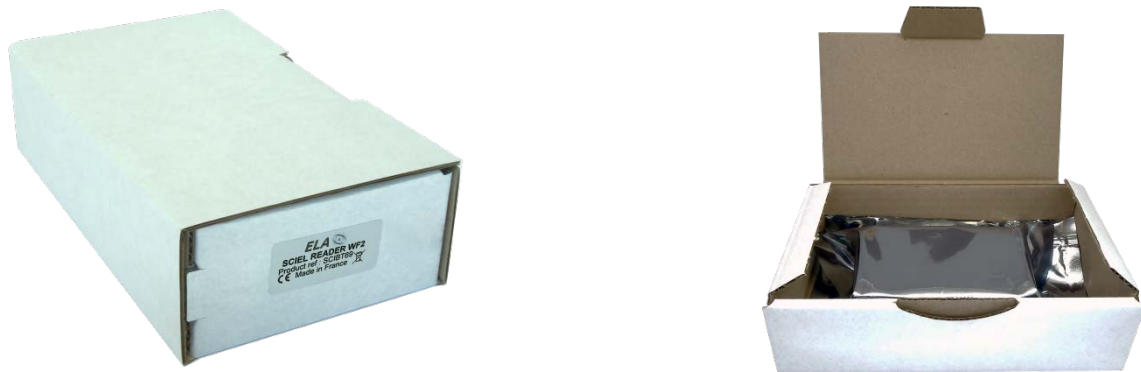

Image 1: The SCIEL READER IP2's packaging



Image 2: The SCIEL READER IP2 and its wifi antenna

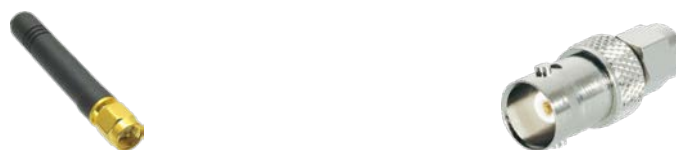

Image 3: 433MHz RFID mini antenna and SMA-M to BNC-F adapter

3 PHYSICAL INFORMATION

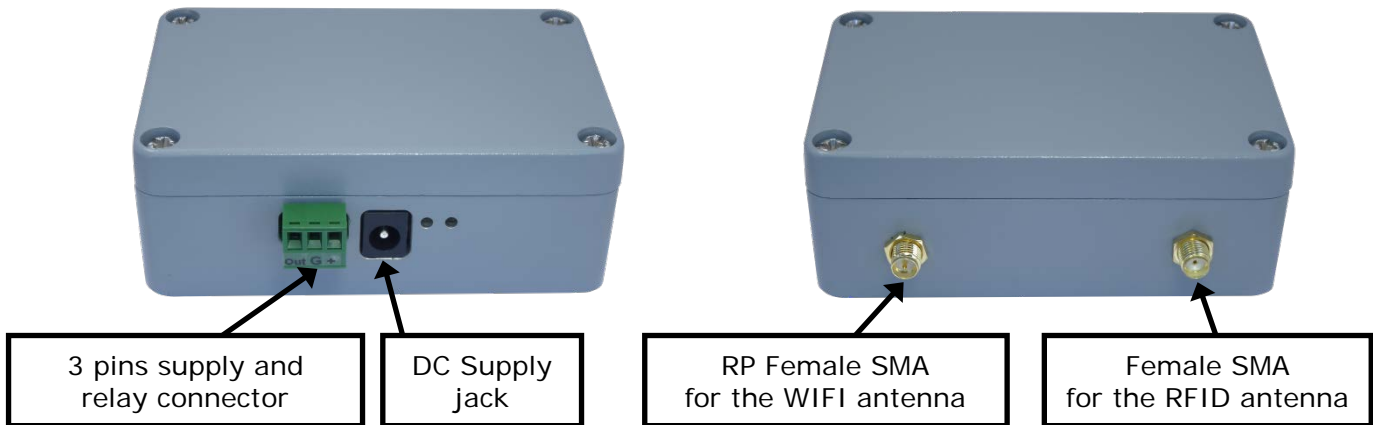

Image 4: SCIEL READER IP connectors

3.1 Antennas connectors

The external RFID antenna connector is a female SMA with a 50Ω impedance. For the wifi, the connector is a male SMA.

3.2 3 pins terminal block wiring



Image 5: 3 pin terminal block

Pin	Description
Out	Relay out (open collector)
G	Ground – Supply negative
+	Supply positive

The *Out* pin can be controlled:

- By sending the instruction [OK0000LL], the relay is turned on for 4 seconds.
- By contextual stack length (number of tags in the detection field): the relay is turned on until the number of tags in the detection field is higher or equal to the number of expected tags (see commands 26/27 in the MCHD “Reader Communication & setup protocol” file on our website).

3.3 Power supply

There are some securities to allow connecting power supplies to the DC jack and the 3 pins connector simultaneously. They are insulated from each other by diodes. If a correct voltage ($9V < V+ < 48V$) is present on at least one of the two connectors, the reader will use the one with the highest voltage.

3.4 LED Indicators

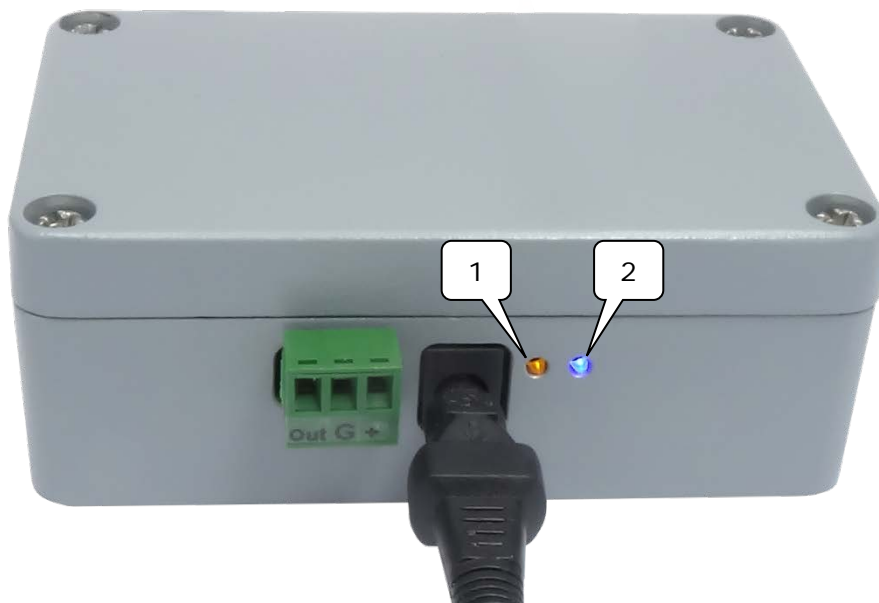

Image 6: LED indicators

LED number	Color	Description	State
1	Yellow	Power Supply present	Permanently lighting
		Data transmission	Blinking
2	Blue	Reader is connected to an active network	Permanently lighting



3.5 Reset button

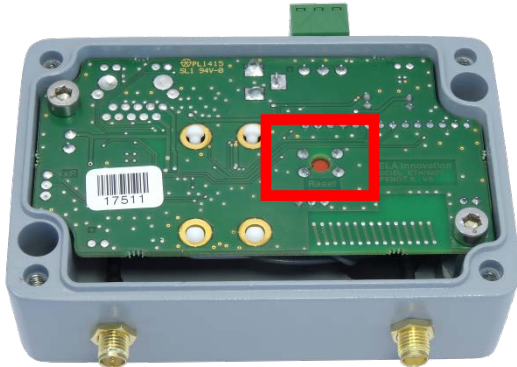

Image 7: Reset button surrounded by the red rectangle

To **reset the Wifi module** to factory settings, **plug a power supply** into the reader, and **press the Reset button** for 10 seconds.
It does NOT reset the reader itself!

To access the Reset button, you have to unscrew the 4 screws on the top of the housing, as shown on the image alongside.



Image 8: 4 screws to be unscrewed

3.6 DIN rail mounting

The SCIEL Reader Wifi2 can be mounted on a standard DIN rail.
To do this, you need our DIN CLIP 01 accessory, a screwdriver and a 3mm hex key. Open the reader's housing by unscrewing the 4 screws on the top (see image above).



Image 9: Main board's screws

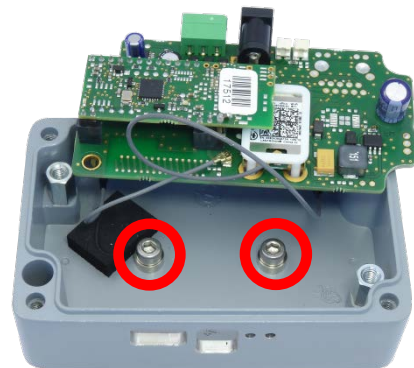

Image 10: DIN rail screws

First, unplug all the power supplies and other cables from the reader.
Unscrew the 2 screws that block the main board.

Remove carefully the main board and pick the 2 screws up. Keep them for the following operations



Image 11: DIN rail mount

Remove the washer on the 2 screws of the previous step. Keep them for later use.

Reassemble the whole unit. Don't tighten the main board's screws too hard, otherwise you could **make damages** ! Place the DIN CLIP 01 accessory as shown on the image alongside, and screw it.

Now the reader can be mounted on a standard DIN rail.

4 READER'S OPERATING MODE

4.1 Physical setup

- Plug an antenna on the female SMA.
You can use the included SMA-Male -> BNC-Female adapter if your antenna has a BNC plug.
- Plug a DC power supply to the DC jack or wire it to the pins 'G' (ground) and '+' (positive) of the 3 pins block.
- Plug the wifi antenna on the male SMA.



Image 12: Readers's LEDs working

For the following, refer to *3.4 LED Indicators*.

The reader's yellow LED must be on (blinking or permanent): that means the reader is correctly supplied.

The reader's blue LED must be on too: that means the network is working.

These two LEDs are surrounded by a red rectangle in the image above.

4.2 Software setup

You will need the *ETER* software: <http://www.rfid-ela.eu/Local/ela/files/562/ETERSetup3.0.1.exe>
 If the link above is not working anymore or if you want to update it, it is available in the Download section of our website: <http://www.rfid-ela.eu/download.html>.
 For this document, we used *ETER* v3.0.1. Some things might change if you use different versions. Install it on your computer, then you can follow the procedure below.

4.2.1 Setup the Lantronix Wifi module



Image 13: Connect to the wifi Lantronix module

Plug a power supply to your SCIEL Reader Wifi2: the yellow LED should be on or blinking. Search for the reader in the wifi network list, and connect to it. See image above. Its name is *XpicoWifi_* followed by the last 6 characters of its MAC address. You can find this address on the sticker on the reader's housing.
The wifi key is : *XPICOWIFI*

Open an internet browser, and navigate to the Lantronix module configuration page at <http://192.168.0.1>.

You will be asked for an ID and a password. Enter the following:

ID: *admin*

Password: *PASSWORD*

If you have set another password that you don't remember, you can reset the Lantronix module by pressing the *Reset* button for more than 10 seconds (refer to 3.5 *Reset button*) and restart the procedure from 4.2.1 *Setup the Lantronix Wifi module*.



Image 14: Status page for the Lantronix module

When you connect to the Lantronix module, you will get into the status page. In the red rectangle, you can see the current state of the wifi interface *wlan0*. With factory settings, the *Connection State* field is *Disconnected*, as in the image above. In this case, the blue LED of the reader is off. The more used tabs are *Quick Connect*, *Line* and *Network*, circled with yellow.

4.2.1.1 Quick Connect tab

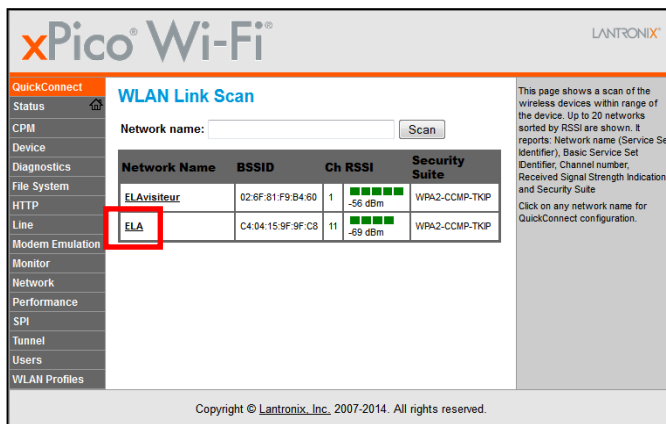

Image 15: Quick Connect page

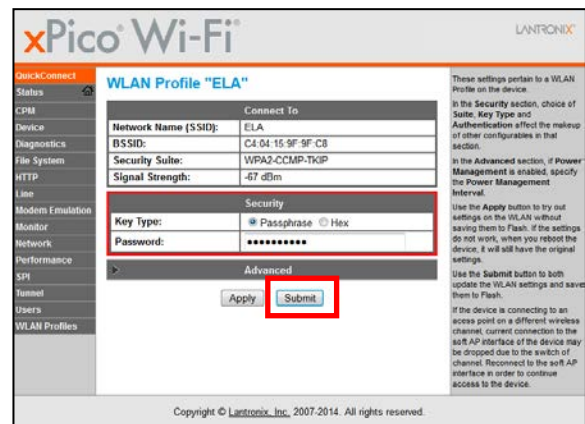

Image 16: Quick Connect page – 2

In *Quick Connect*, **click on the name of the network** you want the reader to be connected on. In this example, we connect the reader to the *ELA* network, surrounded with red.

Enter the password of your network then click *Submit*. You will be shown a warning message. Click *OK*.

When the reader is connected, its **blue LED lights on**.
 In the *Status* tab, the **Connection State should have changed to Connected**.
 You can see the new IP of the reader and other network parameters.
Remember the IP address.

Interface wlan0	
Connection State:	Connected
Radio Firmware Version:	2.3.1
Active WLAN Profile:	ELA
IP Address:	192.168.0.101/24
Default Gateway:	192.168.0.3
Hostname:	
Primary DNS:	80.10.246.2
Secondary DNS:	80.10.246.129

Image 17: Status page with reader connected

From this point, you can disconnect from the reader and connect to your network, then navigate to the reader's IP address in a browser.
 You will be asked again for an ID and a password. Enter again *admin* and *PASSWORD*.

4.2.1.2 Network tab

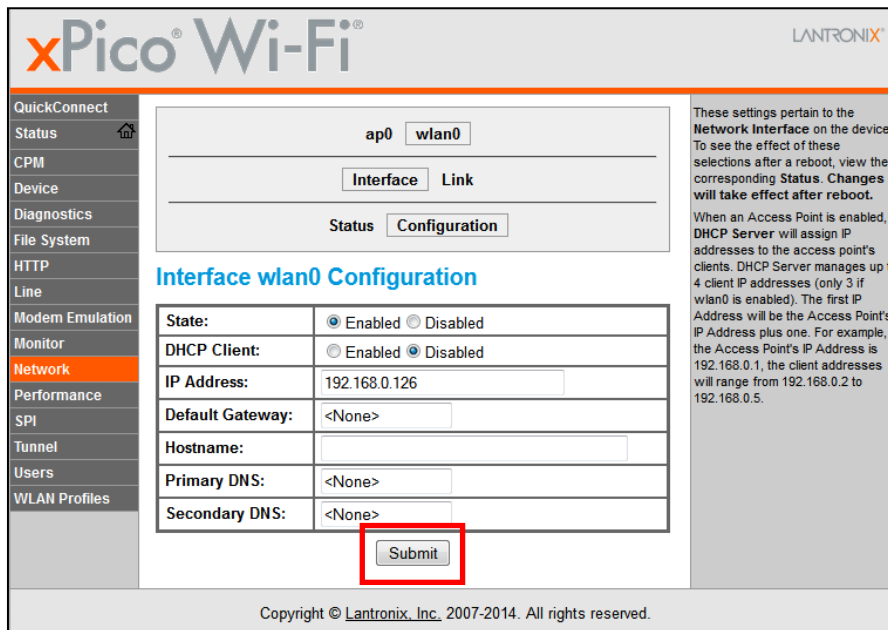

Image 18: Network configuration page

In the *Network* page, you can configure the reader's IP address and other network settings. To do this, select **wlan0** (wifi network), **Interface** and **Configuration**, and fill the fields with the values you want to assign to the reader.
 Important notice: to set fixed parameters, **set DHCP Client to Disabled**. Otherwise, parameters will stay in automatic mode.
 Once you have done that, click on **Submit** then **reboot** the reader (unplug/replug the DC power or click on *Reboot* then *Okay* in the *Device* tab).

4.2.1.3 Line tab



Image 19: Line tab

From this step, if you know what you do and want to keep the Wifi module with factory settings (auto IP, 9600 bauds RS232, no security ...), you can go to 4.2.2 Setup and test the reader with ETER.

Else, if you have already set a password that you don't remember, you can reset the Lantronix module by pressing the *Reset* button for more than 10 seconds (refer to 3.5 Reset button) and restart the procedure from 4.2.1 Setup the Lantronix Wifi module.

The main parameter on this page is the *Baud Rate*, surrounded with red.

To change it, **you must follow the two steps below in the order!**



1. **Change the SCIEL CARD's serial speed** with *ETER* software by sending the command: [13xxRR]. Replace xx by the value you need and RR by your reader's ID. For more details, refer to 4.2.2 Setup and test the reader with ETER and 4.3 Configuration commands list.
2. **Change the Lantronix module's speed after changing the SCIEL CARDS's one.**

If you modify the module's speed before, it won't be able to communicate with the SCIEL CARD nor tell it to use the new speed.

In this case, the backup action is to reset the WIFI module. To do it, please refer to the chapter 3.5.

To apply the new settings, click *OK*, then *Apply Settings* and wait for it to finish.

4.2.2 Setup and test the reader with ETER

ETER is an abbreviation for ELA Terminal. It's designed to communicate with ELA's readers using serial protocols.

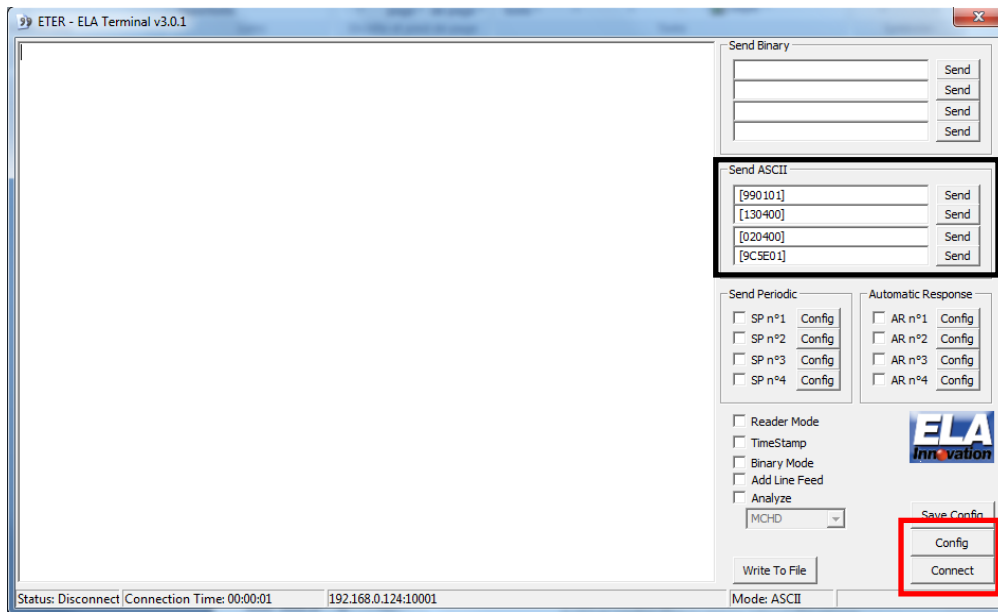

Image 20: ETER v3.0.1

In the black rectangle, you can enter the commands to send to the reader. They will only be sent if the communication port is open.

To configure the serial or IP port, click *Config*. See the image below for more details.

Click *Connect* to open the serial ports and start communicating with the reader.

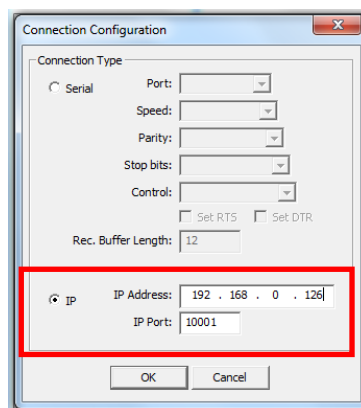

Image 21: ETER -> Config

When you click on *Config* (Image 24), a setting window shows up (image above).

Tick the *IP* box and enter the reader's IP address (see red rectangle).

Click *OK*, then *Connect* (Image 24) to start the communication.

If you reader receives some tags and is set to online mode (factory set), you will see the tags' frames printed on the screen.

4.3 Configuration Command List

For a complete list of the ELA's commands, refer to our Software Datasheet MCHD: *Reader Communication & setup protocol*, available on our website <http://www.rfid-ela.eu/download.html>

All commands have the same syntax:

[AABBCC]

- A command starts by '[' and finishes by ']'
- "AA" : Command number
- "BB" : Command parameter
 - o 6 hex characters for commands A1 and A3
 - o 2 hex characters for all other commands
- "CC" : Reader ID
 - o **Broadcast** to all readers: 00

If the reader understands the command, it will answer **[OKAABBCC]**.

If you want to get some **help** about a command, replace the closing bracket ']' by '?'.

The more important command is: **[990101]**.

It shows the list of all the commands available for the reader, and the actual value for the corresponding parameters.

You can see below a sample line from the **[990101]** command:

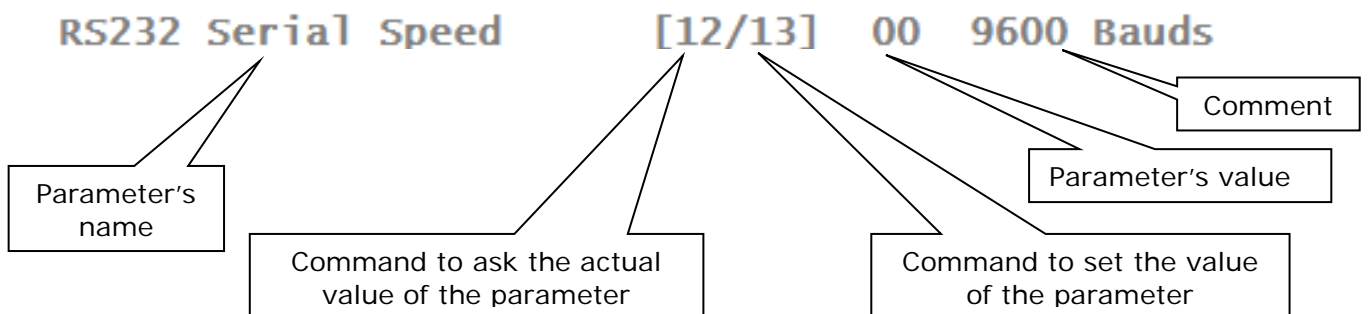

For example, if you want some help about the speed command, send **[130000?]**, you will get the answer alongside.

To get the actual speed of the SCIEL CARD, you must send **[120001]**. It will answer **[120001]** because we are at 9600 bauds.

To set the SCIEL CARD's speed to 115200 bauds, you must send **[130401]**. The reader will answer **[OK130401]**, but you won't see it because the Lantronix module is still at 9600 bauds, so it won't understand the SCIEL CARD's message (this is a particular case; usually you will get the answer message because the speed stays the same)

```

-----RS232 Serial Speed-----
Serial port Communication
Speed.

get: [12xx01]
set: [13xx01]
-00h 9600 Bauds
-01h 19200 Bauds
-02h 38400 Bauds
-03h 57600 Bauds
-04h 115200 Bauds
-----
    
```



5 Dimensions

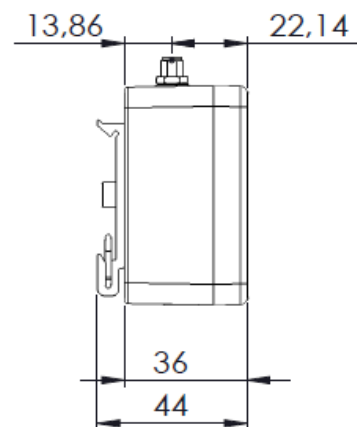
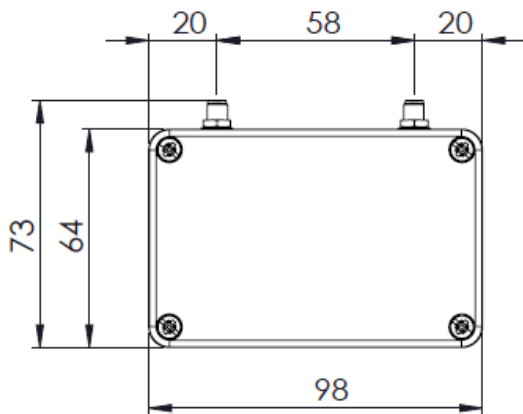
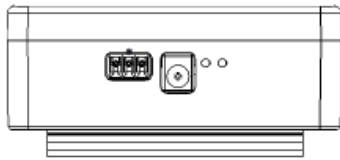
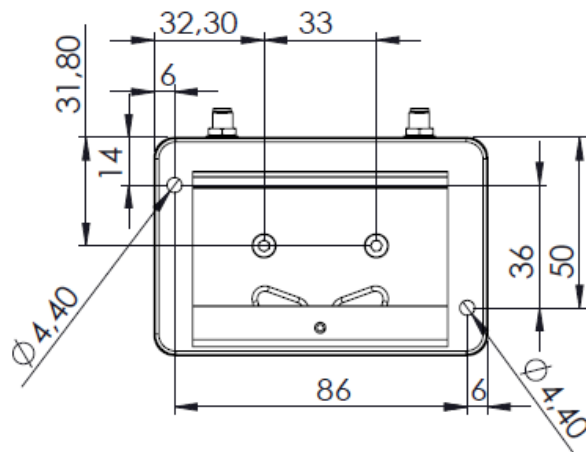

5.1 2D drawings



6 REFERENCES AND VERSIONS

Model	Reference P/N	Specifications
SCIEL READER WF2	SCIBT69B	9-48VDC - 433.92 Mhz
SCIEL READER WF2H	SCIBT84	9-48VDC - 868 Mhz
DIN CLIP 01	ACIOM70	DIN RAIL Kit

7 STANDARDS

-  EN 301 489 – 3 : 2002 V1.4.1 ; EN 300 220 – 2007 : V2.1.2
-  CE Mark
-  RoHS Certified

8 DOCUMENT VERSION

Version	Date	Author	Changes
01A	23/09/14	CZ	First UK document version
02A	22/11/16	LA	Reference updated: SCIBT69B

STATUS	DRAFT	CORRECTION	FINAL
			
DISTRIBUTION LEVEL	CONFIDENTIAL	LIMITED	GENERAL
			